

## SideControl Positioner

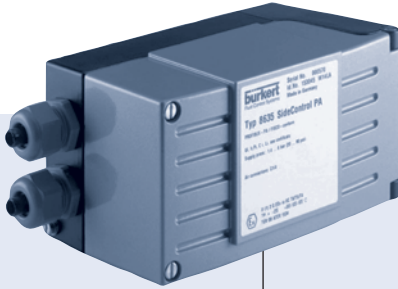

- Electropneumatic positioner for pneumatically actuated process valves
- II (1) 2 G EEx ia IIC T6 approval
- PROFIBUS PA

Type 8635 can be combined with...

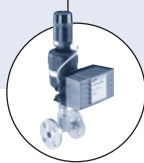

**Type 2712**  
Globe valve

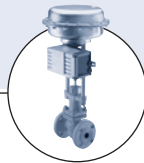

Globe valve  
acc. to NAMUR/IEC

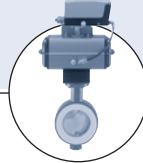

**Typ 8805**  
rotary actuator

The SideControl Positioner Type 8635 is an electropneumatic positioner for pneumatically actuated process valves with linear or part-turn actuators. It is available in the versions 8635 PA and 8635 S. Both versions are executed in two-conductor technology. With Type 8635 PA, communication and energy supply are via PROFIBUS PA whereas with Type 8635 S, the input signal serves for setpoint transmission and energy supply of the device simultaneously.

Signal processing, control and actuation of the internal positioning system are accomplished with microprocessor-controlled electronics. The software function Autotune implemented therein enables automatic adaptation of the positioner to the control valve in use.

The positioner is parametrized and operated comfortably via three operating keys and a plain-text display, or with Engineering-Tools via PROFIBUS PA (Type 8635 PA). It is possible to set up a decentralized control system if a process controller with PID characteristics is used (Type 8635 S).

As an option, the SideControl Positioner Type 8635 can be supplied with approval for use in the Ex area (Zone 1) to ATEX. Because of its compact and robust design, the housing is suitable for use in chemical and process engineering.

Technical data	
<b>Body material</b>	Aluminium, hard anodized and plastic coated
<b>Other external parts</b>	Stainless steel V4A
<b>Seal material</b>	NBR, Neoprene
<b>Control medium</b>	Instrument air
Processing	DIN ISO 8573-1
Dust content	Class 5 ( $\leq 40 \mu\text{m}$ particle size)
Particle density	Class 5 ( $\leq 10 \text{ mg/m}^3$ )
Pressure dew point	min. $10^\circ$ under min. operating conditions
Oil concentration	Class 3 ( $\leq 1 \text{ mg/m}^3$ )
<b>Control air temperature</b>	$-25 \dots +60 \text{ }^\circ\text{C}^{(1)}$
<b>Ambient temperature</b>	$-25 \dots +60 \text{ }^\circ\text{C}^{(1)}$
<b>Supply pressure</b>	$1.4 \dots 6 \text{ bar}^{(3)}$
<b>Air flow capacity<sup>2)</sup></b>	$55 \text{ l/min}$ at $1.4 \text{ bar}^{(3)}$
<b>Control valve</b>	$170 \text{ l/min}$ at $6 \text{ bar}^{(3)}$ for pressurizing and venting
<b>Intrinsic air consumption</b>	$0 \text{ l/min}$
<b>Positioning range</b>	
Linear actuator	$3 \dots 130 \text{ mm}$
Part-turn actuator	$0 \dots 120^\circ$
<b>Position sensor system</b>	High-resolution, conductive plastic, rotary potentiometer
<b>Operation</b>	Operating keys and plain-text display
<b>Communication</b>	
Type 8635 PA	PROFIBUS PA acc. to IEC 1158-2 Profil B for actuators Version 3
<b>Operating software</b>	
Type 8635 PA	<ul style="list-style-type: none"> <li>▪ SIMANTIC PDM</li> <li>▪ others on request</li> </ul>
<b>Electrical connection</b>	<ul style="list-style-type: none"> <li>2 x M20 x 1.5-bushing</li> <li>Clamping range <math>6 \dots 12 \text{ mm}</math></li> <li>Screw terminals for <math>0.14 \dots 1.5 \text{ mm}^2</math></li> </ul>

## Technical data (continued)

Technical data	
<b>Electrical data</b>	
<b>Type 8635 PA</b>	
Operating voltage to Ex-segment coupler	9 ... 15 V DC (Ex)
to segment coupler	9 ... 24 V DC (NonEx)
Operating current	12 mA without FDE, from Bus
Fault current protection	5 mA (FDE)
<b>Electrical data</b>	
<b>Type 8635 S</b>	
Current supply for electronics	via setpoint signal
Burden voltage	4 ... 20 mA
Setpoint setting	< 10.2 V DC
	4 ... 20 mA
<b>Control air sockets</b>	
	G 1/4
	NPT 1/4; RC 1/4 on request

Technical data	
<b>Mounting kits</b>	Namur recommendation acc. to DIN IEC 534 T6 acc. to VDI/VDE 3845
for linear actuator	
for part-turn actuator	
<b>Weight</b>	ca. 1.5 kg
<b>Protection class</b>	IP65 acc. to EN 60529
<b>Type of ignition protection</b>	II (1) 2 G EEx ia IIC T6 acc. to DIN EN 50020
<b>Certification</b>	
Type 8635 PA	acc. to ATEX 2038 (PTB03)
Type 8635 S	acc. to ATEX 2027 (PTB04)
<b>Conformity</b>	▪ EMV-89/336/EWG

<sup>1)</sup> Up to +65 °C temperature class T4/T5 or without EEx i approval.

<sup>2)</sup> May be adapted to actuator size with throttle screw.

<sup>3)</sup> Pressure data in bar; overpressure to ambient.

<sup>4)</sup> FDT: Field Device Tool

## Other Electrical Data

	Function values	8635 PA		8635 S		Permissible maxima as per Certificate of Conformity		
		8635 PA	8635 S	8635 PA	8635 S	8635 PA	8635 S	8635 S
Power Supply	U	9 ... 15 V	10.2 V	Ui	15 V	30 V		
	I	12 mA bus-supplied	4 mA	li	215 mA	100 mA		
				Pi	1.95 W	1 W		
Process value input (only for version with process controller)	Burden	-	10 Ω	Ui	-	30 V		
	Burden voltage U	-	< 200 mV	li	-	100 mA		
				Ci	-	14.3 nF		
				Pi	-	1 W		
Binary input	make/break contact (conf.)	-	-	Co	40 μF	5.5 μF		
				Lo	1000 mH	1000 mH		
Analog feedback (Option)	U	-	12 ... 30 V	Uo	-	30 V		
	I	-	4 ... 20 mA	lo	-	100 mA		
				Po	-	1 W		
Limit switches (Option) (NAMUR initiators)	U	8 V	8 V	Uo	15.5 V	15.5 V		
	I uncoated	3 mA	3 mA	lo	52 mA	52 mA		
	I coated	1 mA	1 mA	Po	150 mA	150 mA		

## Typ 8635 S:

### Recommendations for isolation transformers / DC transformers input 4 ... 20 mA / output 4 ... 20 mA

Company	Model	Burden	Ex	active/passive
Pepperl+Fuchs	KFD2-CD-Ex1.32	850 Ω	x	A
Foxboro Eckardt	TV228-S-EGX	700 Ω	x	A
Foxboro Eckardt	MT228-S-EGX	750 Ω	x	A
Foxboro Eckardt	II949-S1 ZZZ	750 Ω	-	A
Stahl	9318/16-22-10	700 Ω	x	A
Stahl	M318/12-11-00	1000 Ω	x	A
PhoenixContact	PI/EX-ID-I/I	800 Ω	x	A

- Data given without guarantee of accuracy.
- For dimensioning and operation of intrinsically safe circuits, the user/owner is responsible.

## Software functions (depending on the device configuration chosen)

### Type 8635 PA / Type 8635 S

- Automatic commissioning of control system
- Parametrization of the positioner
- Automatic or manual entry of characteristic curve for correction of operating characteristic
- Setting of the tight-closure or maximum stroke threshold
- Stroke limitation
- Limitation of positioning speed
- Dead band
- Direction of action of the controller setpoint
- Signal range splitting (split range up to 4 times)
- Setting of direction of movement
- Definition of a safety position
- Calibration of input and display
- Configuration of binary input
- Code protection for settings/operation
- RESET of factory settings

Software functions (depending on the device configuration chosen)

Other software functions on Type 8635 S

- Optional built-in process controller (PID)
- Automatic parametrization of the process controller
- Setting of the parameters of the process controller
- Calibration of the setpoint input and display
- Configuration of the analog input
- Configuration of the binary input and binary outputs

Dimensions [mm]

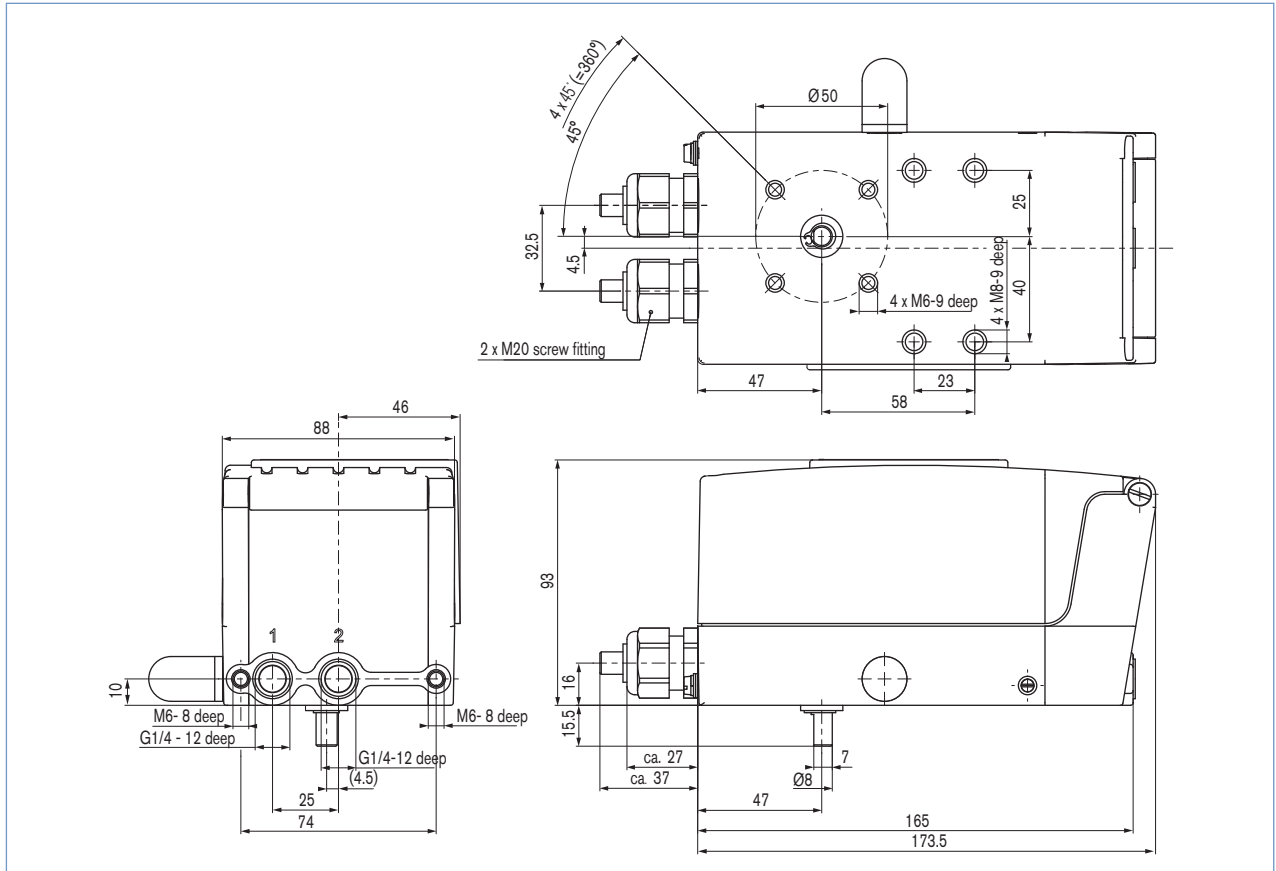

Interfaces

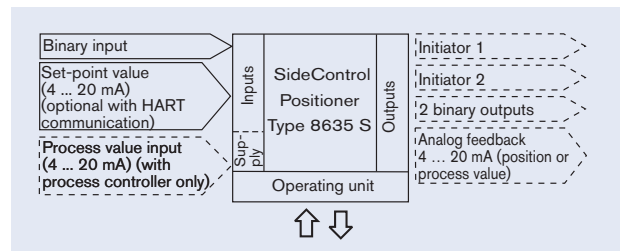
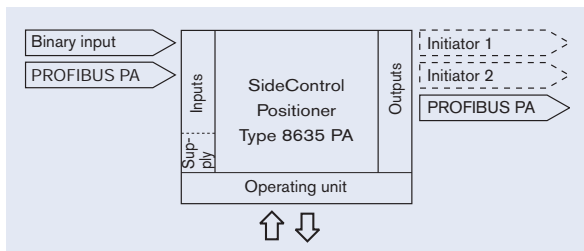

Note

The optional inputs and outputs are shown by dotted lines.

## Ordering chart (excerpt, other versions on request)

### Type 8635 PA

Function <sup>1)</sup>	Initiator DIN EN 60947-5-6	Position sensor system	Mounting on pneumatic linear or part-turn actuator	EEEx approval (acc. to ATEX)	Item no.
Pos	none	internal	acc. to NAMUR <sup>2)</sup>	EEEx ia II C T6	147 275
Pos	2 open/close	internal	acc. to NAMUR <sup>2)</sup>	EEEx ia II C T6	160 543
Pos	none	internal	acc. to NAMUR <sup>2)</sup>	none	155 368
Pos		external	mounting on control valve Type 27XX	EEEx ia II C T6	153 045
Pos		external	mounting on control valve type 27XX	none	155 367

<sup>1)</sup> Pos: positioner  
<sup>2)</sup> DIN/IEC 534-6;  
 VDI/VDE 3845

Type 8635 PA is designed for attachment to single-acting actuators.

#### Other Options:

- External position sensor system
- Universal integrated attachment (air channelling without piping)
- Manometer block VA (inlet air and actuator chamber)
- Initiators to NAMUR as limit switches (optional)

### Typ 8635 S

Function <sup>1)</sup>	Position sensor system	Communi- cation	Initiator DIN EN 60947-5-6	Analog feedback incl. 2 binary outputs	Mounting on pneumatic linear or part-turn actuator	EEEx approval (acc. to ATEX)	Item no.
Pos	external	none		no	mounting on control valve Type 27XX	EEEx ia II C T6	150 347
Pos	external	none		yes	mounting on control valve Type 27XX	EEEx ia II C T6	155 369
Pos	internal	none		no	NAMUR (DIN IEC 534-6; VDI/VDE 3845)	EEEx ia II C T6	147 263
Pos	internal	none	2 open/close	no	NAMUR (DIN IEC 534-6; VDI/VDE 3845)	EEEx ia II C T6	160 542
Pos	internal	none		yes	NAMUR (DIN IEC 534-6; VDI/VDE 3845)	EEEx ia II C T6	155 371
Pos	internal	none	2 open/close	yes	NAMUR (DIN IEC 534-6; VDI/VDE 3845)	none	160 667
Pos+Process	external	none		no	mounting on control valve Type 27XX	EEEx ia II C T6	151 111
Pos+Process	external	none		yes	mounting on control valve Type 27XX	EEEx ia II C T6	155 373
Pos+Process	internal	none		no	NAMUR (DIN IEC 534-6; VDI/VDE 3845)	EEEx ia II C T6	147 264
Pos+Process	internal	none		yes	NAMUR (DIN IEC 534-6; VDI/VDE 3845)	EEEx ia II C T6	155 375
Pos	internal	none		no	NAMUR (DIN IEC 534-6; VDI/VDE 3845)	none	147 265
Pos	external	none		no	mounting on control valve Type 27XX	none	147 267
Pos+Process	internal	none		no	NAMUR (DIN IEC 534-6; VDI/VDE 3845)	none	147 266
Pos+Process	external	none		no	mounting on control valve Type 27XX	none	147 268

<sup>1)</sup> Pos.: positioner; pro: process controller

Type 8635 S is designed for attachment to single-acting actuators.

#### Other options

- Universal integrated attachment (air channelling without piping)
- Manometer block VA (inlet air and actuator chamber)
- Initiators to NAMUR as limit switches (optional)

## Ordering chart for accessories

Version	Item no.
Mounting kit for linear actuators to DIN IEC 534-6	787 215
Mounting kit for part turn actuators to VDI/VDE 3845, without bracket	787 338
Console VA VDI/VDE3845-ISO5211 FO5 for attachment to a pneumatic actuator from ball valve, Type 8805	672 243
Manometer block with 2 manometers, VA	654 602
Attachment kit for piston actuators type 27XX, 80 mm	651 771
Attachment kit for piston actuators type 27XX, 100 mm/125 mm	651 772
Attachment kit for piston actuators type 27XX, 175 mm/225 mm	655 567
Position sensor system for piston actuators type 27XX, 80 mm	651 751
Position sensor system for piston actuators type 27XX, 100 mm/125 mm	653 021
Position sensor system for piston actuators type 27XX, 175 mm/225 mm	655 535

### Ordering note

When attached to a Burkert control valve, the SideControl positioner type 8635 PA/S will be supplied only as part of a complete control valve (positioner, position sensor system, associated attached parts and control valve).

- To select a suitable control valve, use the data sheets of types 27XX.  
To order a complete control valve, state the following numbers:
  - the order no. of the SideControl positioner type 8635 PA/S
  - the order no. of the position sensor system,
  - the order no. of the selected control valve and
  - the order no. of the associated attached parts with the remark SideControl positioner type 8635 PA/S control valve.
- Burkert supplies a completely assembled and tested control valve.

To find your nearest Burkert facility, click on the orange box →

[www.burkert.com](http://www.burkert.com)

If case of special conditions  
please consult for advice.

Subject to alterations.  
© Christian Bürkert GmbH & Co. KG

0809/4\_EU-en\_00891939